

USER MANUAL
5.0" MONITOR & CAMERA KIT

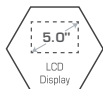

Thank you for purchasing Parkmate's **RVK-50** Reversing System. We are certain that our product will give you trouble-free operation while providing you with a safety feature that enhances your driving experience. Our products, like most after-market safety enhanced devices, are designed to assist and aid the driver, not to replace the manual function of the person operating the vehicle.

DISCLAIMER: Parkmate's **RVK-50** rear-view system is designed as a driver assistance device. Although this is a visual aid and will allow you to view what is behind the vehicle, it does not remove the responsibility of driving the vehicle from the driver. The legal responsibility and safe driving practise remains with the driver at all times. You have purchased this product with the understanding that its use is as an aid only. We highly recommend that you have this product professionally installed to ensure that it will provide the functions it is set out to perform.

IMPORTANT NOTICE:

1. Please read this manual carefully before using the product.
2. This unit is for vehicles with 12V DC only.
3. 12V IGN/ACC Power wiring connections **MUST** be made to a 12V ignition feed. (Refer to Wiring Diagram).
4. Route wiring harness away from heat sources and electrical components.
5. Wire connection points should be insulated.
6. Please install this unit in a professional manner.
7. Please perform tests after finishing the installation.
8. Specifications subject to change without prior notice.

RVK-50 COMPONENT LIST:

- 1 x 5.0" Monitor
- 1 x Rear View Camera
- 1 x Window Suction Mount
- 1 x Dash Mount
- 2 x Power Cable
- 1 x 6M Extension Cable



SPECIFICATIONS (MONITOR):

- Display:** 5.0" (16:9 ratio diagonal length)
- Power:** $\leq 3W$
- Power supply:** 9 – 16V DC
- Resolution:** 480(W)*R.G.B.*272(H)
PAL/NTSC compatible
- 2 AV inputs (allows up to two cameras)
- Auto activation upon reverse gear engagement
- Adjustable brightness
- 180 degree rotational swivel stand



SPECIFICATIONS (CAMERA):

- Resolution:** 420 TV Lines
- Effective pixels:** NTSC = 648 x 488
- Power supply:** 9 – 16V DC
- Operating Temperature:** -20°C – +70°C
- Horizontal Angle:** 170° degrees
- Water-proof rating:** IP67
- Minimum Illumination:** 0.5 Lux
- Normal to Mirror image switching
- Grid-line switching

WIRING DIAGRAM:

Front view option: RVK-50 functions as a rear view camera as standard and also supports front view application. For front view application, you can cut the thin WHITE wire near the camera lead and restart power to see the image display reversed.

Grid-line option: RVK-50 comes with parking grid-lines. To remove the grid-line application, you can cut the thin GREEN wire near the camera lead and restart power to show the removal of grid-lines on your screen.

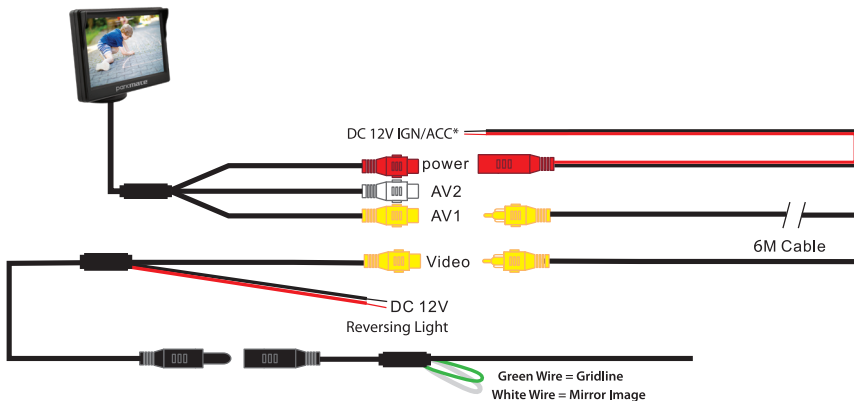

*Please note: This DC 12V IGN/ACC cable MUST be directly connected to a 12V Ignition Feed.

INSTALLATION - BUTTERFLY MOUNT

1. Select a flat and centred location near the number plate lamp at the rear of the vehicle to mount camera.

IMPORTANT: When selecting this location it is highly recommended that the image transmitted by the camera show the rear bumper and area behind the vehicle.

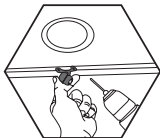
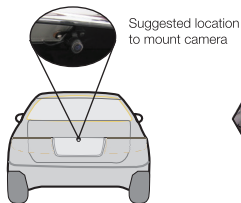

2. Attach tape to the bracket of the camera, and drill a small hole for the first screw.

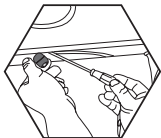

3. Use a screw driver to fix the first screw, but don't tighten it yet.



4. Insert camera wire through newly drilled hole and mount securely in place.

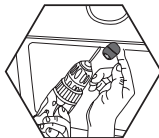

5. Mark the position suitable for the second screw and drill a small hole for it.

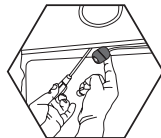

6. Fix the second screw and tighten both screws.

TESTING:

How to test:

1. Apply the parking brakes. (Safety precaution)
2. Turn Ignition on. (DO NOT TURN ON VEHICLE)
3. Shift into reverse gear.
4. Image should appear on the monitor.

INSTALLATION DIAGRAM:

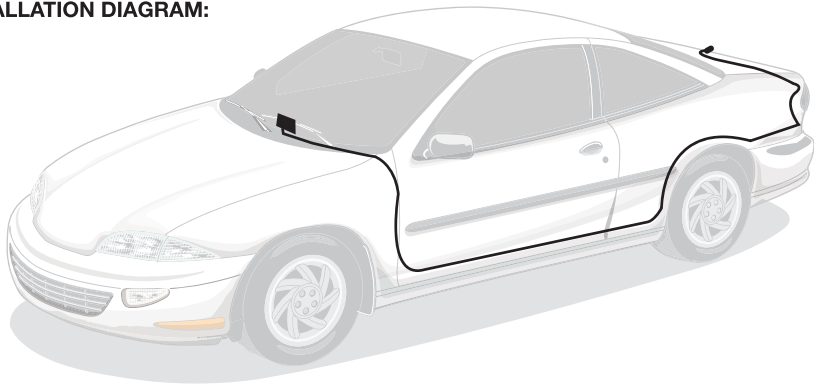

MAINTENANCE:

Always keep camera clear from dirt and mud. Clean camera with a soft moist cloth.

Problem	Solution
"No Signal" appears while reversing	<ol style="list-style-type: none">1. Check video input connections2. Check camera power connections
Video image is not sharp	Check camera lens for debris

TROUBLE SHOOTING:

WARRANTY TERMS & CONDITIONS:

Our goods come with guarantees that cannot be excluded under the Australian & New Zealand Consumer Law. You are entitled to a replacement or refund for a major failure and for compensation for any other reasonably foreseeable loss or damage. You are also entitled to have the goods repaired or replaced if the goods fail to be of acceptable quality and the failure does not amount to a major failure.

This warranty is provided in addition to your rights under the Australian & New Zealand Consumer Law.

Directed warrants that this product is free from defects in material and workmanship for a period of 12 months from the date of purchase or for the period stated on the packaging. This warranty is only valid where you have used the product in accordance with any recommendations or instructions provided by Directed.

This warranty excludes defects resulting from alterations of the product, accident, misuse, abuse or neglect.

In order to claim the warranty, you must return the product to the retailer from which it was purchased or if that retailer is part of a National network, a store within that chain, along with satisfactory proof of purchase. The retailer will then return the goods to Directed. Directed will repair, replace or refurbish the product at its discretion. The retailer will contact you when the product is ready for collection. All costs involved in claiming this warranty, including the cost of the retailer sending the product to Directed, will be borne by you.

Directed Electronics Address: 44 Translink Drive, Keilor Park Victoria Australia 3042

Ph: +61 03 8331 4800

Email: service@parkmate.com.au

To view the complete Parkmate range or for details on how to contact us, please visit our website at **www.parkmate.com.au**

parkmate[®]
YOUR SAFETY COMES FIRST[™]

parkmate[®]
YOUR SAFETY COMES FIRST[™]

www.parkmate.com.au
www.parkmatehd.co.nz

DIRECTED
AUSTRALIA & NZ



All Images, Information and Content are Copyright © 2018 Directed Electronics Australia Pty Ltd. All Rights Reserved.

© Parkmate 2018 V2.1