

parkmate®

User Manual

5.0" Smart Screen Monitor With Front Dash Camera

YOUR SAFETY COMES FIRST™



ClearView 5

PM-51W

CONTENTS

Cautions	4
Warning	5
Micro SD card warning	5
1.0 Introduction	6
2.0 Package contents	6
3.0 Product overview	8
4.0 Micro SD card installation	9
5.0 Product installation	10
5.1 Windscreen suction mount.....	10
5.2 3M adhesive suction mount.....	12
6.0 Power connection	14
6.1 Auto power on/off	14
7.0 Micro SD card	15
7.1 Formatting inserted Micro SD card	15
7.2 Micro SD card specifications	15

8.0	Home screen	17
8.1	Dash camera.....	18
8.2	Apple CarPlay	20
8.2.1	iPhone set-up	20
8.3	Android Auto	22
8.3.1	Android Auto set-up	23
9.0	Audio output	25
9.1	PM-51W speakers	25
9.2	Car Audio.....	26
9.3	FM Transmitter	28
9.3.1	FM Transmitter set-up	29
9.4	AUX	29
10.0	Vehicles with bluetooth functionality	30
11.0	Settings	32
12.0	Parking monitor	33
13.0	Troubleshooting	34
14.0	Warranty	35

CAUTIONS

- Please ensure you are using your Dash Camera within your country's road laws.
- Please make sure you are familiar with your local road legislation before use.
- The time and date need to be set before you start recording.
- The notifications provided by this Dash Camera are to be used as a guide only.
- Please drive according to the actual conditions on the road.
- The system is for non-commercial use only, and within the limits permitted by the relevant laws.
- Avoid using this product in the vicinity of any devices that emit radio interference such as microwave ovens.
- Please note that it is normal for this product to get warm during use.
- Please ensure you maintain your focus on the road and not on the monitor while driving.

WARNING

- Always power this product using the supplied charger.
- Never dismantle this product.
- Do not dispose of this product in fire.
- Disposal of this product should observe local regulations.

MICRO SD CARD WARNING

- This product can only be used with Micro SD Cards, Class 10 or above with 32GB to 256GB storage capacity. The Micro SD card is not included and will need to be purchased separately.
- Please format your Micro SD card before use. (Please see Section 8.1 on page 15 for details on how to format).

NOTE:

- Formatting the Micro SD card will delete all information on the inserted Micro SD Card.
- PM-51W does not support multi-touch on the navigation menu. Please use the keys on the screen for navigation.

1.0 INTRODUCTION

Thank you for purchasing a Parkmate ClearView 5 Wireless Smart Monitor with Front Dash Camera. This product enables your smartphone to be seamlessly connected via Bluetooth and Wi-Fi for hands-free operation while driving. It also comprises an integrated front Dash Camera to facilitate hassle-free driving and navigation.

Please read through these instructions before attempting to install this product. For the latest manual and product updates, please visit our website at:

www.parkmate.com.au
www.parkmatehd.co.nz

2.0 PACKAGE CONTENTS

1. Smart 5.0" Monitor x1
2. 3M Adhesive Mount Plate x1
3. 12/24V Power Adaptor x1
4. AUX Cable x1
5. User Manual x1
6. Suction Mount x1
7. Quick Start Guide x1

3.0 PRODUCT OVERVIEW

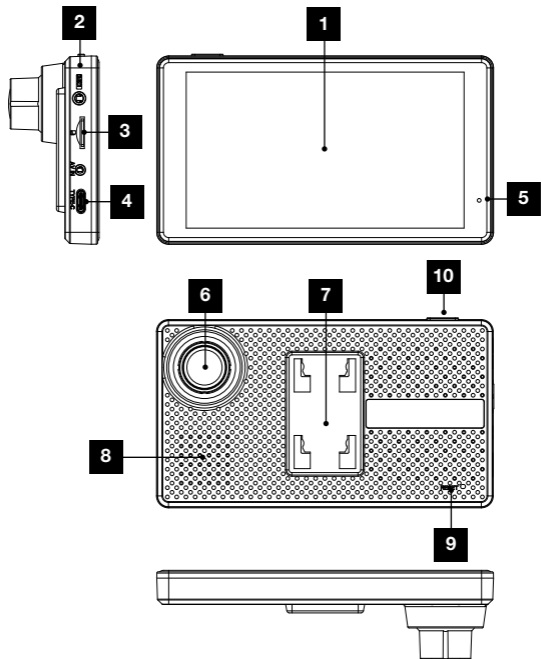

1. Display screen
2. AUX input
3. Micro SD card slot
4. Type-C connector (for power supply)
5. Microphone
6. Front camera lens
7. Suction mount
8. Speaker vent
9. Reset button - Press this button to restart the device. (All pre saved information will be lost).
10. Power button - Long press to power on/off. Short press to turn on/off display. (Recording will continue).

4.0 MICRO SD CARD INSTALLATION

Please insert the memory card into the Micro SD Card slot with the chip contact surface facing up. Insert it until you hear a click sound.

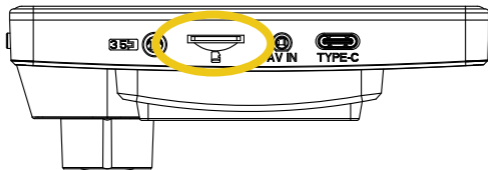

5.0 PRODUCT INSTALLATION

There are two mounting options available for installation:

1. Windscreen suction mount
2. 3M adhesive mount

5.1 WINDSCREEN SUCTION MOUNT

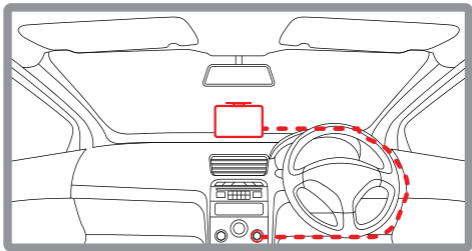
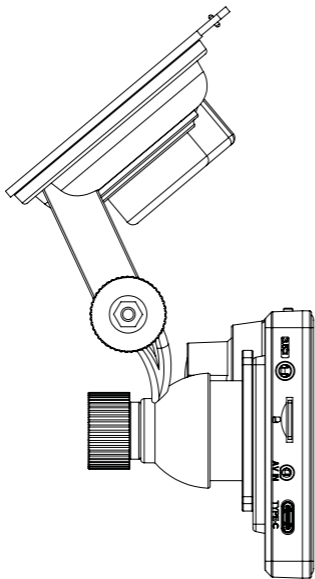

Figure: 1

- Clean the windscreen area where the suction mount is to be mounted.
- Unlock the suction mount lock by turning the lock at the back of suction cup clockwise towards the arrow.
- Press the suction mount on the windscreen and lock it by turning the lock anti-clockwise towards the arrow.



1. Lock the mount behind the Monitor.
2. Adjust the angle of the mount.

5.2 3M ADHESIVE SUCTION MOUNT

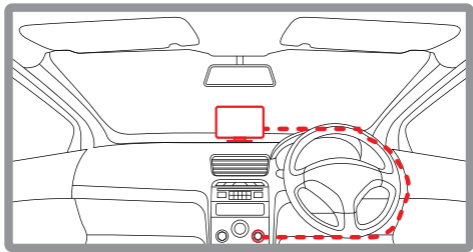
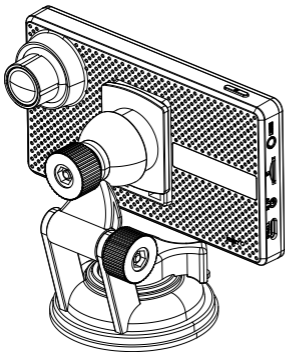

Figure: 2

- Clean the area on the dashboard where the mount is to be placed.
- Remove the 3M tape at the bottom of the 3M dash mount base .
- Place the mount on the cleaned surface and press it firmly for two minutes.



1. Attach the suction mount to the dash mount base.
2. Attach the ClearView 5 to the suction mount.
3. Firmly press the base onto the desired position for one minute to ensure that the adhesive makes full contact with the intended installation position.

MOUNTING NOTES

- Make sure the camera lens is within the range of the windscreen wiper so that there is a clear line of view when it rains.
- Do not touch the camera lens. Fingerprints on the lens will result in unclear videos or photos. If your photos or videos are blurred, this may be rectified by cleaning the lens gently with a microfibre cloth.
- Please use only the included charging cable to power the Smart Monitor. Other cables may not work or may damage the product.

6.0 POWER CONNECTION

- Only use the supplied 12/24V power adaptor to power the ClearView 5.
- Once the ClearView 5 is securely installed on the windscreen or dashboard, plug the 12/24V power adaptor cable into the vehicle's 12/24V power port.
- Run the cable along the vehicle's dashboard and plug the Type-C connector into the ClearView 5. (See Figure 1 or Figure 2).
- The power adaptor has a USB A port with 1A output. This port can be used to charge your smartphone and to connect to CarPlay if your smartphone does not support wireless CarPlay or Android Auto connection.
- The 1A output from the USB A port may not be sufficient for use with Qi charging products. Please check your Qi charging specifications.

6.1 AUTO POWER ON/OFF

When the ClearView 5 is correctly installed and connected to the vehicle 12/24V power port, it will automatically power up and start recording when the vehicle ignition is turned on.

NOTE:

- The ClearView 5 is designed to be powered only by the supplied DC power plug. Its internal battery is **NOT** designed for primary use.

7.0 MICRO SD CARD

7.1 FORMATTING INSERTED MICRO SD CARD

It is highly recommended to format the Micro SD card before use.

7.2 MICRO SD CARD SPECIFICATIONS

The quality of Micro SD card you use has a great impact on the stability of video recording.

It is recommended to use Micro SD cards from these brands for best results: ScanDisk, Kingston, Toshiba and Samsung.

Speed certification must be at least Class 10 with a minimum capacity of 32GB and maximum 256GB.

Formatting the Micro SD card will delete all previously saved information on the inserted card and prepare the card for use with the Smart Monitor.

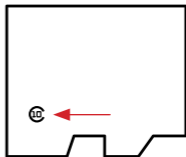

To format the Micro SD card, please follow the steps below:

1. Press the Settings  button

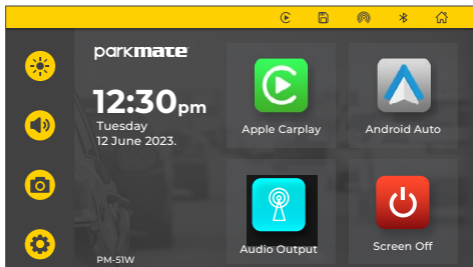

2. Press the "**Format**" button. Your Micro SD card will now begin to format.

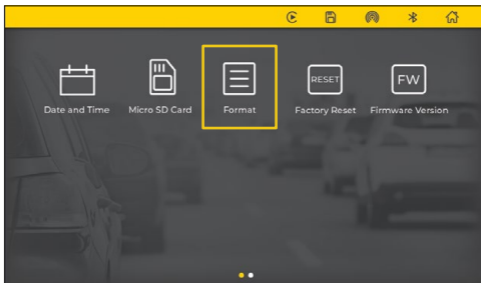

8.0 HOME SCREEN

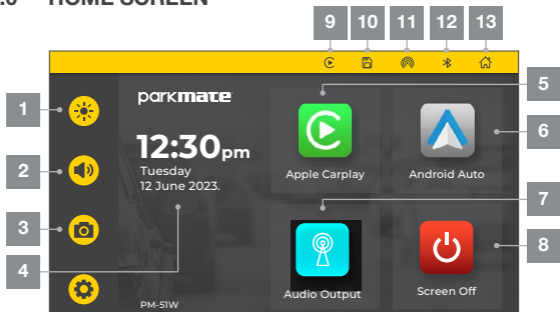

1. **Brightness button:** Touch to adjust screen brightness.
2. **Volume button:** Touch to adjust the volume.
3. **Dash Camera:** Touch to enter into the video recording interface.
4. **Date and time:** Displays the current date and time.
5. **Apple CarPlay:** Touch to enter the instructions to connect with iPhone.
6. **Android Auto:** Touch to enter the instructions to connect with Android phones.
7. **Audio Output:** Touch to change audio settings.

8. **Display button:** Touch to turn off the screen, and touch anywhere on the screen again to wake up the screen.
9. **Video Recording Indicator**
10. **Micro SD Card Indicator**
11. **Wi-Fi Connection Indicator**
12. **Bluetooth Connection Indicator**
13. **Home Button:** Touch to return to Home Screen.

8.1 DASH CAMERA

After the Micro SD card is successfully inserted and formatted, the system will start recording.

The dot will turn red indicating that the device is in recording mode.

Touch the Dash Camera button to enter into the camera interface as shown in the image below.



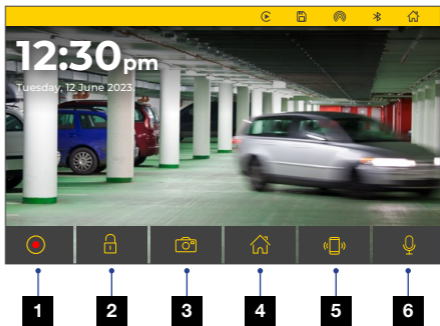

1. **Record:** Touch to stop recording. A blinking red button indicates that recording is in progress.
2. **Lock file:** Touch to lock the one-minute recorded video file and protect it from being overwritten.
3. **Camera:** Touch to take photo.
4. **Main menu:** Touch to return to Main menu.
5. **Phone menu:** Touch to return to Phone menu.
6. **Audio recording:** Touch to enable or disable audio recording.

8.2 APPLE CARPLAY

FOR FIRST-TIME CONNECTION

Touch the Apply CarPlay icon to show the connecting instructions. After first connection, it will show "Connected" and display the Apple CarPlay menu.

8.2.1 IPHONE SET-UP

1. Touch the Apple CarPlay icon on the display screen.
2. Use Bluetooth to pair your iPhone with the device.
3. After pairing, select CarPlay when prompted.
4. The Smart Monitor will now automatically connect to your iPhone via Wi-Fi.

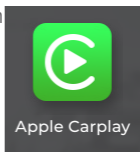

NOTE:

- First-time connection will take slightly longer.
- Only compatible with iOS 13.0 or higher version.

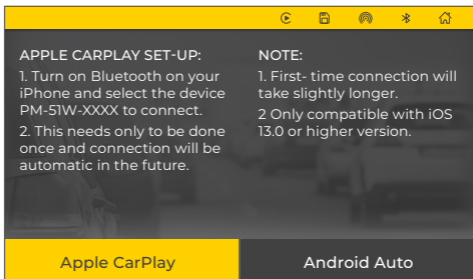

- Please turn on Bluetooth and Wi-Fi on your iPhone.
- Pair your iPhone with the Smart Monitor.
- After successful Bluetooth pairing, Wi-Fi will automatically connect between the ClearView 5 and your iPhone.

From now on, connection between the ClearView 5 and your iPhone will be automatic each time the ClearView 5 is powered on when your iPhone is within close proximity.

Press Exit to return to the ClearView 5 Menu.

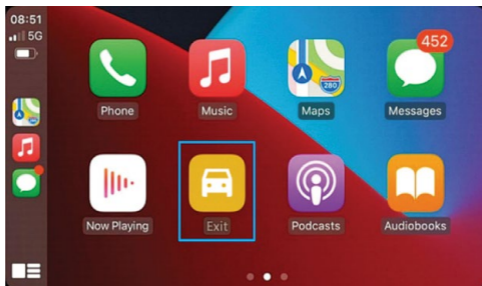

8.3 ANDROID AUTO

FOR FIRST-TIME CONNECTION

Touch the Android Auto icon to show the connecting instructions. After first connection, it will show Connected and display the Android Auto menu.

8.3.1 ANDROID AUTO SET-UP

Please ensure that you have downloaded the latest Android Auto app from the Google Play Store to your smartphone.

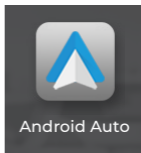

Use Bluetooth to pair your Android phone with the Smart Monitor.

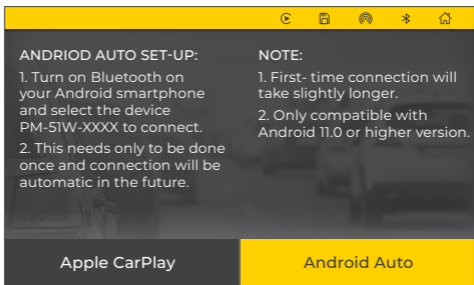

NOTE:

- First-time connection will take slightly longer.
- Only compatible with Android 11.0 or higher version.

From now on, connection between the ClearView 5 and your Android phone will be automatic each time the ClearView 5 is powered on when your Android phone is within close proximity.

Press Exit to return to the ClearView 5 Menu.

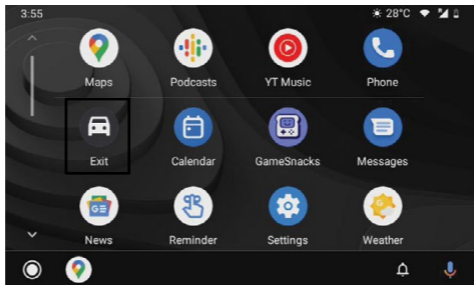

9.0 AUDIO OUTPUT

9.1 PM-51W SPEAKERS

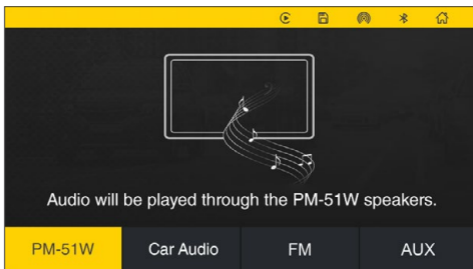

Select "**PM-51W**" to play audio through the device's built-in speaker.

9.2 CAR AUDIO

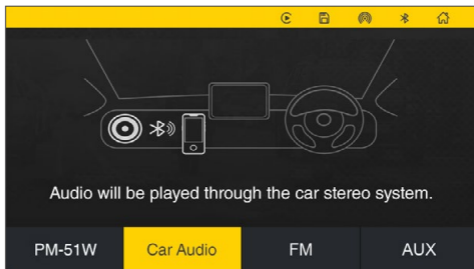

Select "**Car Audio**" to play audio either through your smartphone speaker or the car stereo speakers if your smartphone is connected via Bluetooth to the device. This selection only needs to be done once to maintain the same selection.

Under Android Auto mode, in the Bluetooth settings for the ClearView 5 on your smartphone, it is suggested to disable the "**Media Audio**" so that the default audio is via the ClearView 5 built-in speaker when connected to your smartphone. This only applies to Android Auto mode.

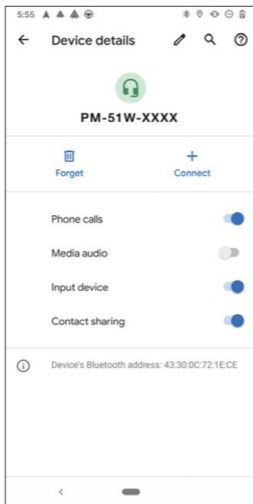

9.3 FM TRANSMITTER

Select “**FM**” button to enter into the FM Transmitter settings.

The FM Transmitter can be used to transmit audio from the ClearView 5 to your vehicle’s built-in stereo speakers.

When you turn on the FM Transmitter, the ClearView 5 will be muted. You will have to match the frequency of the FM Transmitter to a free frequency channel on the vehicle head unit to hear the audio from the ClearView 5.



9.3.1 FM TRANSMITTER SET-UP

1. Turn on the FM Transmitter. The ClearView 5 built-in speaker is now muted.
2. Turn on the vehicle's radio and select a free frequency channel.
3. On your ClearView 5, select the frequency you have chosen on your radio.
4. Once the frequencies are matched, the ClearView 5 will automatically playback its audio through the vehicle's built-in stereo speakers.

9.4 AUX



If your device is connected via an auxiliary cable to the AUX port of your vehicle, select AUX to play the audio through the car stereo speakers.

10.0 VEHICLES WITH BLUETOOTH FUNCTIONALITY

FM TRANSMITTER STATUS	MUSIC/CALLS INITIATED/CALLS RECEIVED/ CALLS INITIATED WITH SIRI/GOOGLE/ NAVIGATION INSTRUCTIONS
FM Transmitter enabled	Played through vehicle's audio system via FM Transmitter.

FM TRANSMITTER STATUS	MUSIC	CALLS INITIATED	CALLS RECEIVED
FM Transmitter disabled and Android phone is connected to vehicle's Bluetooth and ClearView 5	Play through vehicle's audio system or ClearView 5	Played through vehicle's audio system	Played through vehicle's audio system
		Played through vehicle's audio system via ClearView 5	Played through vehicle's audio system via ClearView 5
FM Transmitter disabled and iPhone is connected to vehicle's Bluetooth and ClearView 5	Played through vehicle's audio system or via ClearView 5	Played through vehicle's audio system	Played through vehicle's audio system
		Played through vehicle's audio system via ClearView 5	Played through vehicle's audio system via ClearView 5

PLEASE NOTE

- For Android smartphones, data calls such as Whatsapp cannot be initiated via the vehicle's audio system when connected to ClearView 5.
- Android smartphone users will need to download the Android Auto app from the Google Play Store.
- Calls and navigation functions can be initiated by saying 'Hey Google' or 'OK Google' and 'Hey Siri'. ClearView 5 will use your smartphone data for all CarPlay and Android services.
- Not all apps on your smartphone are accessible via the ClearView 5. It will depend on iOS and Android terms and conditions.

11.0 SETTINGS

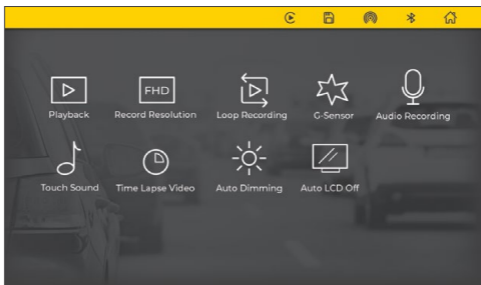

SETTING	OPTION	DEFAULT
Camera Resolution	1080P/2.5K/720P	1080P
Loop recording	1min/3min/5min	1min
Audio recording	On/Off	On
G-Sensor	Off/Low/Mid/High	Low
Date and time	12hr/24hr	12hr
Auto LCD off	Always on/1 min/5mins	Always on
Auto-dimming	On/Off Night Brightness Start/End time	On, 25% Start-6.00am End-6.00pm

12.0 PARKING MONITOR

This function is designed to monitor and record any incident that may occur when your car is parked. The ClearView 5 must be hardwired to your vehicle's electrical circuit for the function to be used.

Recording in Parking Monitor* mode can be done in time lapse mode to save memory space on the Micro SD Card.

NAME	FUNCTION	OPTIONS	DEFAULT	NOTE
Time lapse	To turn on/off time lapse mode	On/Off	Off	When time lapse mode is turned on and the car detects the engine is off, the recording will be done in time lapse mode.
Time lapse duration	To change the duration of time lapse mode	2 hours/ 8 hours / 12 hours / 24 hours/ Always on	Always on	To select the duration of time lapse mode when your car is parked. The ClearView 5 will stop recording after the time lapse duration expires. If set to Always on, time lapse mode will continue until your car is re-started.

*Requires the installation of a 3-wire hardwire kit.

13.0 TROUBLESHOOTING

PROBLEM	SOLUTION
Unable to start the device.	Check whether the DC head of the 12V power cord is damaged or worn.
	Check whether the fuse of the power plug is disconnected or damaged.
No touch control response	Touch control is invalid during powering up of the device. Wait for the device to be powered on before using it.
	Check whether the touch control is damaged. Do not touch the display screen with any sharp object as the screen is easily scratched and damaged.

REMINDER

Please ensure that there is no obstruction between your smartphone and the device and that the Bluetooth and Wi-Fi signal communication is uninterrupted. Otherwise, the functions of the device cannot be used smoothly.

14.0 WARRANTY

WARRANTY TERMS AND CONDITIONS

Our goods come with guarantees that cannot be excluded under the Australian Consumer Law. You are entitled to a replacement or refund for a major failure and for compensation for any other reasonably foreseeable loss or damage. You are also entitled to have the goods repaired or replaced if the goods fail to be of acceptable quality and the failure does not amount to a major failure.

This warranty is provided in addition to your rights under the Australian Consumer Law. Directed Electronics Australia Pty Ltd (Directed Electronics) warrants that this product is free from defects in material and workmanship for a period of 12 months from the date of purchase or for the period stated on the packaging. This warranty is only valid where you have used the product in accordance with any recommendations or instructions provided by Directed Electronics.

This warranty excludes defects resulting from alterations of the product, accident, misuse, abuse or neglect. In order to claim the warranty, you must return the product to the retailer from which it was purchased or if that retailer is part of a National network, a store within that chain,

along with satisfactory proof of purchase. The retailer will then return the goods to Directed Electronics.

Directed Electronics will repair, replace or refurbish the product at its discretion. The retailer will contact you when the product is ready for collection. All costs involved in claiming this warranty, including the cost of the retailer sending the product to Directed Electronics, will be borne by you.

Phone: +61 03 8331 4800

Email: info@parkmate.com.au

INDEMNITY

You agree to defend, indemnify and hold harmless Parkmate and its subsidiaries and affiliates from and against any and all claims, proceedings, injuries, liabilities, losses, costs and expenses (including reasonable legal fees), including but not limited to, claims alleging negligence, invasion of privacy, copyright infringement and/or trademark infringement against Parkmate and its subsidiaries and affiliates, relating to or arising out of your breach of any provision of these terms, your misuse of Parkmate products or its services, or your unauthorised modification or alteration of products or software.

WARRANTY AND WARRANTY DISCLAIMER

Parkmate has a limited warranty on whereby Parkmate warrants to you and only to you that Parkmate products will be free from defects in materials and workmanship for one (1) year from the date of your purchase (unless a longer warranty period is required by law). The specifics of this Parkmate limited warranty are covered in this manual. To the extent possible under governing law, other than the above product warranty for the Parkmate product you understand and agree that the Parkmate products and services are provided on an "as is" and "as available" basis.

Parkmate makes no warranty that the Parkmate products and services will meet your requirements or that use of the Parkmate products and services will be uninterrupted, timely, secure or error-free. Nor Parkmate make any warranty as to the accuracy or reliability of any information obtained through the Parkmate (including third party content), that any defects in the Parkmate will be corrected or that the Parkmate products or services will be compatible with any other specific hardware or service. Further, Parkmate does not warrant that the Parkmate or the Parkmate servers that provide you with data and content are free of viruses or other harmful components.

Parkmate also assumes no responsibility for and shall not be liable for any damages caused by viruses that may infect your Parkmate.

In the event of any loss, damage or injury, you will not look to Parkmate to compensate you or anyone else. You release and waive for yourself and your insurer all subrogation and other rights to recover against Parkmate arising as a result of the payment of any claim for loss, damage or injury.

Parkmate equipment and services do not cause and cannot eliminate occurrences of certain events, including, and Parkmate makes no guarantee or warranty, including any implied warranty of merchantability or fitness for a particular purpose, that the Parkmate equipment and services provided will detect or avert such incidents or their consequences.

Parkmate does not undertake any risk that you or property, or the person or property of others, may be subject to injury or loss if such an event occurs. The allocation of such risk remains with you, not Parkmate.

Other than the above product warranty for the Parkmate, its suppliers disclaim all warranties of any kind, whether express, implied, or statutory, regarding Parkmate products and services, including any implied warranty of title,

merchantability, fitness for a particular purpose, or noninfringement of third party rights.

Because some jurisdictions do not permit the exclusion of implied warranties, the last sentence of this section may not apply to you. Parkmate hereby further expressly disclaims all liability for any claims for service failures that are due to normal product wear, product misuse, abuse, product modification, improper product selection or your non-compliance with all applicable federal, state or local laws.

This warranty and warranty disclaimer give you specific legal rights, and you may have other rights that vary by state, province, or country. Other than as permitted by law, Parkmate does not exclude, limit or suspend other rights you have, including those that may arise from the nonconformity of a sales contract.

For a full understanding of your rights you should consult the laws of your state, province, or country. For our Australian customers:

Please note that this warranty is in addition to any statutory rights in Australia in relation to your goods which, pursuant to the Australian Consumer Law, cannot be excluded.

LIMITATIONS OF PARKMATE LIABILITY

Under no circumstances will Parkmate be liable in any way for any content, including, but not limited to, the loss of content, any errors or omissions in any content, or any loss or damage of any kind incurred in connection with use of or exposure to any content posted, emailed, accessed, transmitted, or otherwise made available via Parkmate.

Parkmate liability for damages, especially for breach of duty or obligation, delay in performance, non-performance, or malperformance shall be precluded, except when these are due to negligent breaches of any significant contractual duty or obligation on the part of Parkmate. Any liability for negligence is limited to direct losses usually and typically foreseeable in such case. Should the claim for damages be based on wilful or grossly negligent breach of contractual duty or obligation on the part of Parkmate, the preclusion and limitation of liability mentioned in the preceding sentences will not apply. The preceding preclusion and limitation of liability will also not apply to claims for damages arising out of loss of life, bodily injury or health impacts for which Parkmate may be liable, or for non-contractual liability.

Some states and countries do not allow the exclusion or limitation of incidental or consequential damages, so the above limitation or exclusion may not apply to you. Additionally, this provision is not intended to limit Parkmate's liability in the event of Parkmate's wilful or intentional misconduct.

YOUR SAFETY COMES FIRST™

www.parkmate.com.au | www.parkmatehd.co.nz



parkmate

ANOTHER
DIRECTED
BRAND

DIRECTED.
AUSTRALIA & NZ